



Bobcat®

One Tough Animal.

LPG FORKLIFTS

7-Series, Pneumatic, 2.0 to 3.5 ton capacity

🌐 Europe



ONE TOUGH ANIMAL

OUR MISSION

We empower operators to accomplish more, while working in the toughest conditions and tightest situations. When our customers have the will, we provide the way.



BOBCAT'S HISTORY

In 1958, Melroe Manufacturing Company introduced a compact front-end loader that evolved quickly into the M400, the world's first true skid steer loader. The company soon adopted what became the world-famous 'Bobcat' brand – and its success paved the way for the global compact equipment industry we know today.

YEARS OF EXPERIENCE

In 2021, Bobcat expanded its portfolio by acquiring Doosan Industrial Vehicle. This specialist in material handling equipment constructed its first forklift in 1968 and went on to establish a global presence with 400 dealers in 93 countries.



BOBCAT TODAY

Bobcat is expanding its portfolio with the addition of forklifts and reach trucks for the material handling industry. Offering a comprehensive line-up that will meet all your intra-logistics needs. Bobcat forklifts and reach trucks are produced in our factory in Korea, while our premium quality warehouse equipment is made in Germany.



TOUGH, AGILE & SAFE

► READY TO GIVE YOUR BUSINESS A LIFT

Give your business a boost with an LPG forklift that ticks all the boxes: a high-performance, powerful, and efficient engine; smooth and variable controls; and a full suite of safety features—all in a machine that is rugged, dependable, and easy to service, with a low total cost of ownership.

Spacious full cab equipped with extra features for maximum comfort

Fuse and relay box located in front of the engine for easier maintenance

Oil-cooled Disc Brakes for maximum productivity



Excellent visibility through the mast for safer and more efficient worksites
P. 7

Durable frame and mast for safer operation when carrying loads

Good roof visibility for enhanced operator vision during lifting
P. 7



Operator Sensing System (OSS) to prevent any unwanted movements of the truck when the operator leaves the seat
P. 11

Anti-slip step plate for increased safety when getting in & out of your machine

Tool-less removable side panel and floor plate for easy maintenance

Effortless and responsive driving thanks to hydrostatic system



► ULTIMATE PRODUCTIVITY

Get more done daily, thanks to the high-performance yet efficient HMC LP 2.4 L engine with 45.4 kW of power and 300 Nm torque, providing the best-in-class travel and lifting speeds.

P. 7



► ALL-DAY COMFORT

Experience a more comfortable shift with a range of standard quality-of-life features, including an ergonomic seat, easy-to-read instrument panel, ample leg room, anti-slip plate, and more.

P. 8



► DRIVEN BY SAFETY

Enjoy peace of mind provided by the machine's excellent all-around visibility, superb stability, and a full suite of safety features.

P. 10-11



► MAXIMUM UPTIME

Reduce your total cost of ownership by extending service intervals and utilizing high-quality Bobcat genuine parts and consumables, which contribute to smoother and longer-lasting machine performance.

P. 12-13

OUTSTANDING PRODUCTIVITY



EXCELLENT VISIBILITY

Thanks to the precisely designed overhead guard with angled roof bars, low cowl height, and excellent visibility through the mast, you have the best view of the task at hand, enabling you to accomplish more every day.

POWERFUL LPG ENGINE

The high-performance yet efficient HMC LP engine, with 45.4 kW of power, provides best-in-class travel and lifting speeds. A silent chain timing belt and an aluminum cylinder block design keep the noise level to a minimum.



EFFORTLESS DIRECTIONAL CHANGES

The thoroughly tested powershift transmission controls the clutch oil pressure precisely, ensuring smooth shifts between forward and reverse. This careful control helps prevent transmission damage and makes the forklift stronger and longer-lasting.

POWERFUL BRAKING POWER

Oil-cooled disc brakes offer outstanding stopping performance and extended durability with minimal maintenance. The brake systems are entirely sealed to safeguard against external contaminants, ensuring reliable operation.

COMFORT & CONTROLS



▶ EASILY ADJUSTABLE SEAT & COLUMN

The premium suspension seat provides all-day comfort for long shifts and ample space for the operator. The seat and the steering wheel column are easy to adjust, allowing every operator to feel right at home in the cab.

▶ DELUXE SUSPENSION SEAT

The deluxe suspension seat prioritizes operator comfort with an adjustable seat back, extended seat travel length, and front-side weight resistance. These features enable multiple adjustments for the most comfortable seating experience.

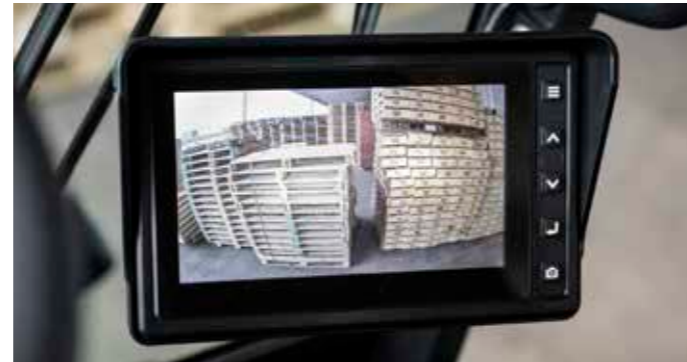

▶ FULL OR MODULAR CABS

Equip your forklift with one of our factory-made cabs to conquer all weather conditions. Enhance comfort for all-day use by adding options such as a heater, operator fan, and power jack.

▶ REAR CAMERA DISPLAY

Equip your machine with a rear camera that feeds into the in-cab display when in reverse, ensuring you always have the best view of your workplace without sacrificing comfort.

▶ RADIO AND MP3 PLAYER



Add a radio and MP3 player to your cab to enjoy even the longest shifts.

▶ WELL-PLACED HANDLES



Stepping in and out of your vehicle is quick and comfortable, thanks to the well-placed entry bar and handles.

▶ ERGONOMIC CONTROLS



Thanks to the ergonomic design and perfect placement of control elements, operating this machine is as easy as can be.



SAFETY IN EVERY MOVE

▶ ADVANCED PROTECTION FOR YOU AND YOUR OPERATION

Bobcat forklifts have safety embedded in their DNA. Packed with tons of features that protect you and your investment, these machines provide peace of mind in every task, every day.

▶ OPERATOR SENSING SYSTEM (OSS)

The truck's travel and mast lifting functions stop when the operator leaves the seat, ensuring the forklift won't perform any unintended movements.



▶ LIMP HOME MODE

In the event of a critical issue, this feature enables the forklift to operate at reduced capacity, empowering operators to safely navigate to a designated area for inspection and repair.



▶ INTERLOCKING 4TH LEVER

The 4th lever will be locked until manually released by pressing the button on the lever. This guarantees load security, eliminating the risk of unintended release.



▶ WEIGHT SCALE

With our weight indicator or scale options, you know immediately if you are overloading your forklift.

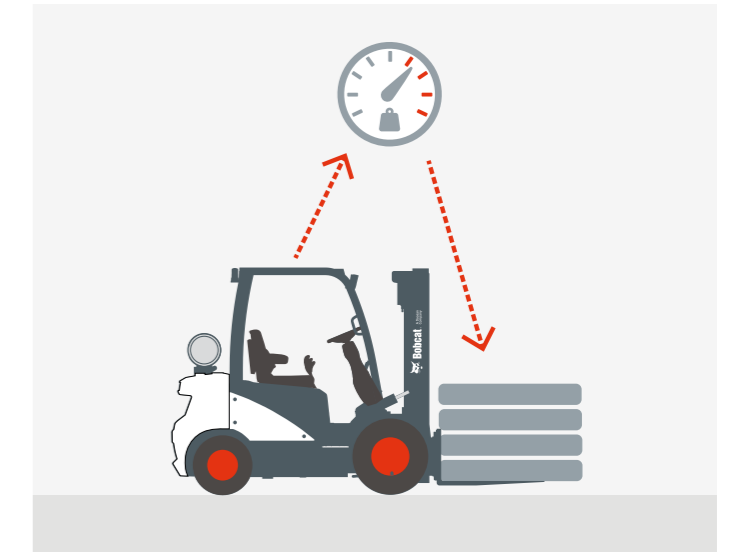

▶ SEAT BELT SEQUENCE INTERLOCK

The operator must be seated with a fastened seat belt to operate the truck.



▶ GROUND SPEED CONTROL

To further enhance the safety of your truck and workplace, you can set up a speed limit to prevent the truck from going too fast. This limit can be customized for both forward and reverse directions.



▶ LARGE PANORAMIC MIRROR

By enhancing rear visibility, the large panoramic mirror improves safety conditions and boosts overall productivity.



▶ POWERFUL LED LIGHTS

The powerful LED lights can brighten even the darkest corners of your workplace, ensuring you're always aware of your surroundings.



BUILT TO LAST

EXCELLENT RELIABILITY

Thanks to the powerful HMC engine, dust- and water-resistant parts, and shock-absorbing hydrostatic power steering, Bobcat's 7-Series LPG forklifts are built tough to provide you with maximum uptime and dependability.

THERE'S NO TIME FOR DOWNTIME. STAND UP TO EVERY TASK THAT COMES YOUR WAY. DAY AFTER DAY.

2 YEAR WARRANTY

WARRANTY

Bobcat develops every machine to the highest standards of quality and durability. That's why our standard warranty provides 24 months or 2 000 operating hours (whichever occurs first) of coverage.



PROTECTION PLUS EXTENDED WARRANTY

Enjoy total peace of mind with Protection Plus extended warranty. Providing the same level of protection as the standard warranty, Protection Plus also reflects different customer needs and expectations by offering a choice of durations and annual operating hours.

EXTENSIVE DEALER NETWORK

You can rely on our network of dealers and service partners who are always ready to help you.

BOBCAT GENUINE PARTS

Quality components delivered to our dealers guarantee that all of our equipment is built to last, withstand the toughest conditions and provide reliable performance.

MAIN SPECIFICATIONS

TECHNICAL DATA ACCORDING TO VDI 2198						
MODEL		G20E-7	G25E-7	G30E-7	G33E-7	G35EC-7
Drive		LPG				
Load capacity (kg)	Q	2 000	2 500	3 000	3 250	3 500
Load center (mm)	c	500				
Load Distance: Center of Drive axle to fork (mm)	x	480		485		495
Wheelbase (mm)	y	1 625		1 700		
Service weight (kg)		3 585	3 965	4 390	4 565	4 770
Tread, front (mm)	b11	975		982		1 026
Tread, rear (mm)	b12	1 000				
Tilt of mast / fork carriage forward / backward (°)	α/β	1				
Height mast lowered (mm)	h1	1 850 – 3 150	1 850 – 3 150	1 565 – 3 140	1 565 – 3 140	1 565 – 3 140
Free lift (mm)	h2	147 – 2 240	147 – 2 240	152 – 2 190	152 – 1 950	152 – 1 770
Lift height (mm)	h3	2 580 – 8 250	2 580 – 8 250	2 030 – 8 250	2 030 – 6 010	1 800 – 3 140
Height, mast extended (mm)	h4	3 290 – 9 210	3 290 – 9 210	3 290 – 9 205	3 290 – 8 615	3 060 – 6 915
Height of overhead guard (mm)	h6	2 183				
Height of seat (mm)	h7	1 026				
Overall length (mm)	l1	3 565	3 630	3 744	3 744	3 809
Length to forkface (mm)	l2	2 530	2 595	2 700	2 730	2 765
Overall width (mm)	b1/b2	1 170		1 197		1 255
Fork dimensions (mm)	s/e/l	40 × 100 × 1 050			45 × 125 × 1 050	
Fork carriage width (mm)	b3	1 103				
Ground clearance, loaded below mast (mm)	m1	115		105		
Ground clearance, center of wheelbase (mm)	m2	143				
Aisle width for pallets 1 000 × 1 200 crossways (mm)	Ast	3 900	3 945	4 050	4 080	4 115
Aisle width for pallets 800 × 1 200 lengthways (mm)	Ast	4 100	4 145	4 250	4 280	4 315
External turning radius (mm)	Wa	2 220	2 265	2 365	2 395	2 420
Travel speed, loaded / unloaded (km/h)		19 / 20			18 / 19	
Lift speed, loaded / unloaded (mm/s)		550 / 570	540 / 570	520 / 570	540 / 590	530 / 590
Lowering speed, loaded / unloaded (mm/s)		510 / 460				
Max. drawbar pull, loaded / unloaded (kg)		2 009 / 1 963	2 059 / 1 984	2 109 / 2 044	2 099 / 2 048	2 019 / 1 957
Gradeability loaded / unloaded (@ 1.6 km/h) (%)		33.6 / 6.4	29.3 / 50.3	26 / 46.5	24.2 / 44.3	22 / 39.6
Max. gradeability loaded / unloaded (%)		38.2 / 3.5	33.4 / 56.7	30 / 52.8	27.9 / 50.4	25.1 / 44.6
Service brake		foot / hydraulic				
Engine manufacturer / type		HMC / G424IE				
Engine power according to DIN ISO1585 (kW)		45.4				
Rated speed (min ⁻¹)		2 600				
Torque at 1/min (Nm)		179				
Number of cylinders / displacement (-/cm ³)		4 / 2,359				
Sound level at the driver's ear according to EN 12 053 (dB(A))		84				

Note: Specification values quoted in this specification sheet have been rounded. Performance may vary depending on operating conditions. Products and specifications are subject to improvement and change without prior notice.

STANDARD EQUIPMENT & OPTIONS

STANDARD EQUIPMENT & OPTIONS		STANDARD EQUIPMENT & OPTIONS	
SAFETY		PRODUCTIVITY	
Operator Sensing System	✓	High-powered, fuel-efficient engine	✓
Mast interlock – tilt, lift and lower	✓	Emission Regulation Stage V	✓
LED front lights	✓	Auto tilt leveling	•
Panoramic and/or large rear-view mirror	✓	Quick disconnect hose couplings	•
Ground speed control	•	SERVICEABILITY	
Rear-view camera	•	Tool-less side panel / floor plate	✓
Strobe lights	•	Junction box (centralized electric components)	✓
Blue safety lights	•	Wide hood open angle	✓
Backup alarm	•	ERGONOMICS	
4 th lever interlock	•	Excellent visibility	✓
Autoshift controller	•	Large entry grip bar	✓
Weight indicator (hydraulic sensing type)	•	Anti-slip step plate	✓
Weight scale (load cell type)	•	Telescopic steering column	✓
RELIABILITY		Modular Cab – Type A,B,C	•
Hydrostatic steering system	✓	Full cab	•
Oil-cooled disc brakes (ODB)	✓	Additional sound suppression	•
Tilt cylinder cover	✓	Rear grab bar with horn	•
Rigid drive-axle (large king pin)	✓	Document clip board	•
Waterproof connectors	✓	Cup holder	•
Dual element air cleaner	✓	Cigar and power jack	•
Pre-cleaner	•	Heater	•
Radiator screen	•	Keyless ignition	•
Vented side panel	•	Operator fan	•
Under protection (belly plate)	•	Radio and MP3 player	•
Engine guard	•	Low fuel indicator	•
Open core radiator	•	Suspension seat (with armrest and heating)	•

*This list is based on factory data. Standard or optional can vary for specific countries. • = option ✓ = standard – = not available

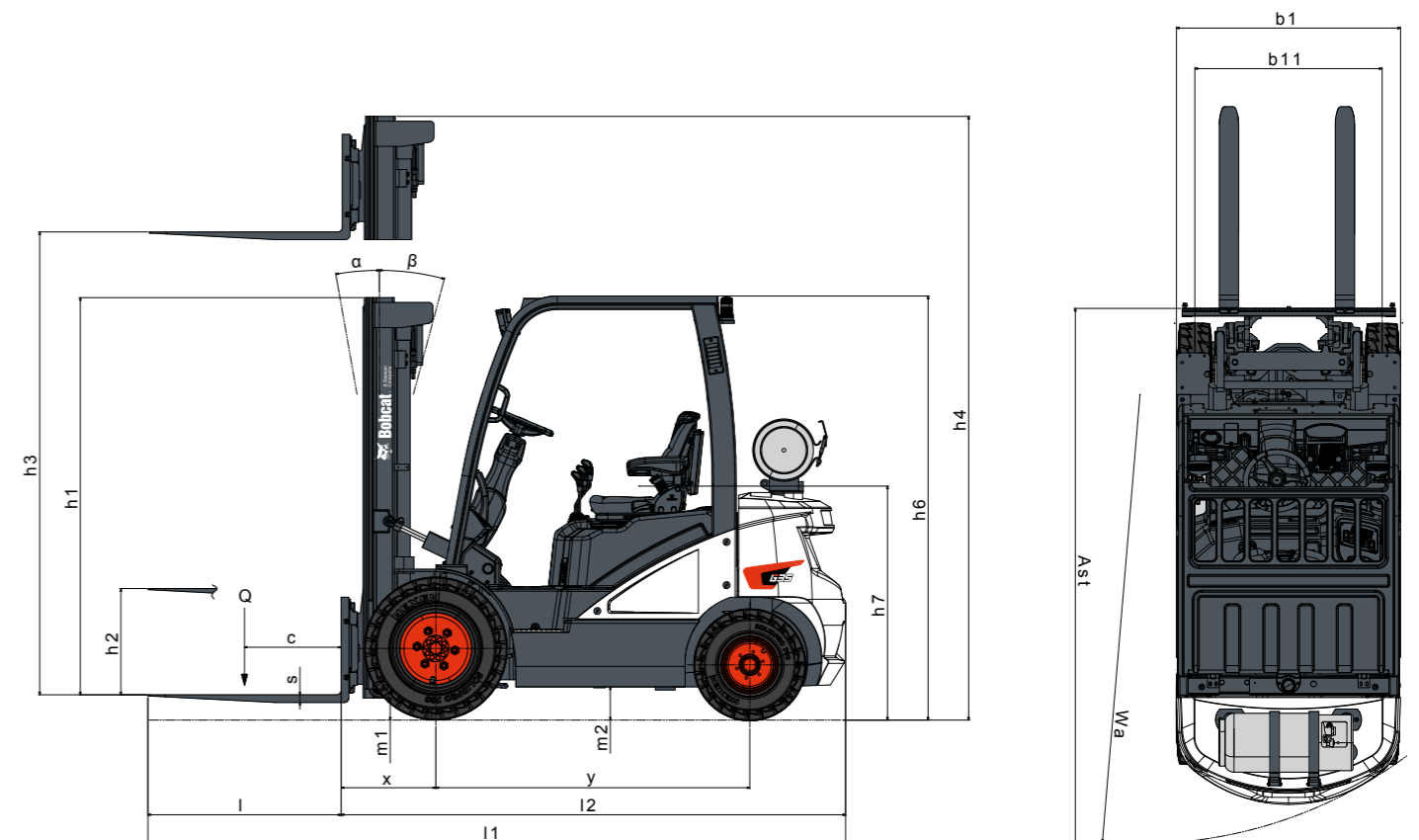

FINANCING OPTIONS

24, 36, OR 48 MONTH FINANCING*

Take advantage of 24, 36 or 48 month financing programs starting from **0% interest** and improve your cashflow.

Ask your dealer for the financing offers available.

340 MACHINES / 150 ATTACHMENT FAMILIES / 1 TOUGH ANIMAL



**SKID-STEER
LOADERS**



**COMPACT TRACK
LOADERS**

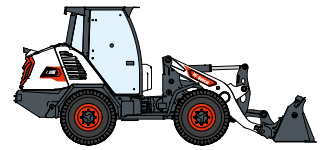

**COMPACT WHEEL
LOADERS**



FORKLIFTS

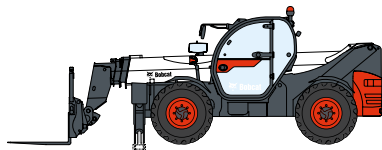

TELEHANDLERS

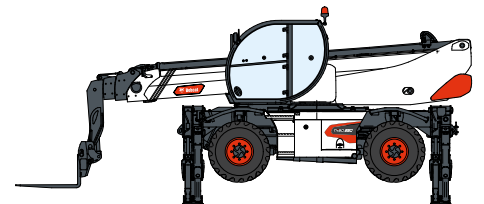

ROTARY TELEHANDLERS



**LIGHT COMPACTION
EQUIPMENT**



**COMPACT
EXCAVATORS**



**COMPACT
TRACTORS**



**SMALL ARTICULATED
LOADERS**



**MINI TRACK
LOADER**



MOWERS



**PORTABLE
POWER**

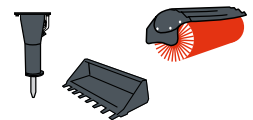

ATTACHMENTS

DOOSAN

Bobcat is a Doosan Company. Doosan is a global leader in construction equipment, power & water solutions, engines, and engineering proudly serving customers and communities for more than a century. | Bobcat and the Bobcat logo are registered trademarks of Bobcat Company in the United States and various other countries. ©2024 Bobcat Company. All Rights Reserved.

www.bobcat.com

©2024 BOBCAT B4502650-EN (01-24)



Bobcat®

*Financing options may vary by country and dealer. Always ask your dealer about currently available financing options. Terms and conditions may apply.

Doosan Bobcat EMEA, U Kodelky 1810, 263 12 Dobříš, Czech Republic